



## INSTRUCTION MANUAL

# DUAL BAND FM TRANSCEIVER IC-T7H

This device complies with Part 15 of the FCC rules. Operation is subject to the following two conditions: (1) This device may not cause harmful interference, and (2) this device must accept any interference received, including interference that may cause undesired operation.

Icom Inc.



---

## IMPORTANT

---

**READ ALL INSTRUCTIONS** carefully and completely before using the transceiver.

**SAVE THIS INSTRUCTION MANUAL**—This instruction manual contains important operating instructions for the IC-T7H.

---

## EXPLICIT DEFINITIONS

---

The explicit definitions below apply to this instruction manual.

WORD	DEFINITION
<b>⚠ WARNING</b>	Personal injury, fire hazard or electric shock may occur.
<b>CAUTION</b>	Equipment damage may occur.
<b>NOTE</b>	If disregarded, inconvenience only. No risk of personal injury, fire or electric shock.



The IC-T7H complies with essential requirements of the 89/336/EEC directive for Electromagnetic Compatibility. This compliance is based on conformity with the ETSI specification ETS300 684 (EMC product standard for Commercially Available Amateur Radio Equipment).

---

## CAUTIONS

---

**⚠ WARNING! NEVER** hold the transceiver so that the antenna is very close to, or touching exposed parts of the body, especially the face or eyes, while transmitting. The transceiver will perform best if the microphone is 5 to 10 cm (2 to 4 in) away from the lips and the transceiver is vertical.

**⚠ WARNING! NEVER** operate the transceiver with a headset or other audio accessories at high volume levels. Hearing experts advise against continuous high volume operation. If you experience a ringing in your ears, reduce the volume level or discontinue use.

**NEVER** connect the transceiver to an AC outlet or to a power source of more than 16 V DC. Such a connection will damage the transceiver.

**NEVER** connect the transceiver to a power source that is DC fused at more than 5 A. Accidental reverse connection will be protected by this fuse, higher fuse values will not give any protection against such accidents and the transceiver will be ruined.

**NEVER** attempt to charge alkaline or dry cell batteries. Beware that external DC power connections will charge batteries inside the battery case. This will damage not only the battery case but also the transceiver.

---

## UNPACKING

---

**DO NOT** push the PTT when not actually desiring to transmit.

**DO NOT** operate the transceiver near unshielded electrical blasting caps or in an explosive atmosphere.

**AVOID** using or placing the transceiver in direct sunlight or in areas with temperatures below  $-10^{\circ}\text{C}$  ( $+14^{\circ}\text{F}$ ) or above  $+60^{\circ}\text{C}$  ( $+140^{\circ}\text{F}$ ).

Place unit in a secure place to avoid inadvertent use by children.

The use of non-Icom battery packs/chargers may impair transceiver performance and invalidate the warranty.

Even when the transceiver power is OFF, a slight current still flows in the circuits. Remove the battery pack or case from the transceiver when not using it for a long time. Otherwise, the battery pack or installed dry cell batteries will become exhausted.

**For U.S.A. only**

**CAUTION:** Changes or modifications to this device, not expressly approved by Icom Inc., could void your authority to operate this device under FCC regulations.

Accessories included with the transceiver:	Qty.
① Antenna.....	1
② Handstrap .....	1
③ Battery pack (BP-173/BP-180) or battery case (BP-170) attached to the transceiver .....	1
④ Belt clip .....	1
⑤ Wall charger*.....	1

\*Not supplied with battery case versions.

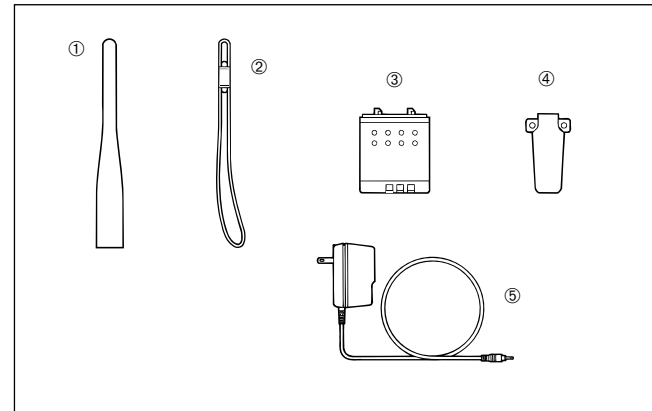

Antenna for U.S.A. version differs from that shown above.

---

# TABLE OF CONTENTS

---

IMPORTANT .....	i	<b>4 ADVANCED FUNCTIONS .....</b>	<b>15 – 22</b>
EXPLICIT DEFINITIONS .....	i	■ Memory/call channels .....	15
CAUTIONS .....	i	■ DTMF memory operation .....	17
UNPACKING .....	ii	■ Scan operation .....	18
TABLE OF CONTENTS .....	iii	■ Subaudible tone operation .....	21
<b>1 PANEL DESCRIPTION .....</b>	<b>1 – 5</b>	<b>5 OTHER FUNCTIONS .....</b>	<b>23 – 26</b>
■ Switches, controls, keys and connectors .....	1	■ Initial set mode .....	23
■ Function display .....	5	■ Channel indication mode .....	26
<b>2 BATTERY PACKS AND ACCESSORIES .....</b>	<b>6 – 9</b>	■ CPU resetting .....	26
■ Battery pack charging .....	6	<b>6 TROUBLESHOOTING .....</b>	<b>27</b>
■ Charging precautions .....	6	<b>7 OPTIONS .....</b>	<b>28</b>
■ About the battery pack .....	6	<b>8 SPECIFICATIONS .....</b>	<b>29</b>
■ Charging connections .....	7	<b>9 MODE ARRANGEMENT .....</b>	<b>30 – 31</b>
■ Battery case .....	8		
■ Accessory attachment .....	9		
<b>3 BASIC OPERATION .....</b>	<b>10 – 14</b>		
■ Power ON .....	10		
■ Setting a frequency .....	10		
■ Setting tuning steps .....	11		
■ Selecting a memory channel .....	12		
■ Lock function .....	12		
■ Receive and transmit .....	12		
■ Repeater operation .....	13		

## ■ Switches, controls, keys and connectors

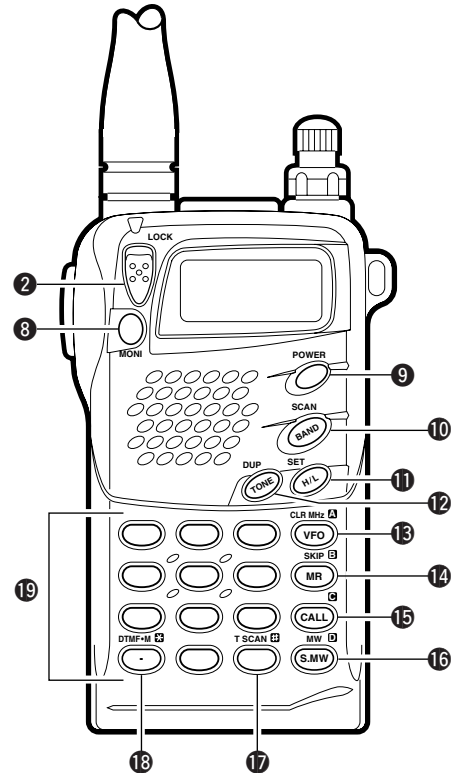
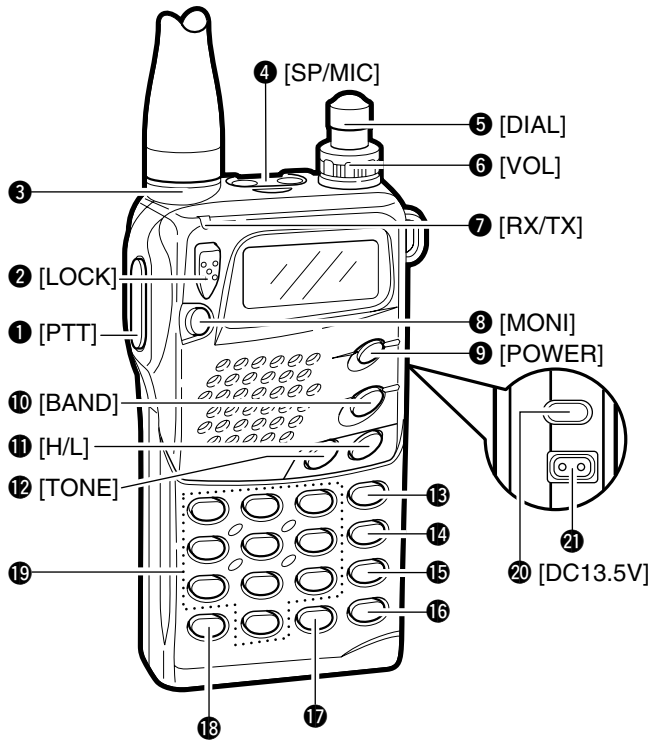

# 1 PANEL DESCRIPTION

## 1 PTT SWITCH [PTT] (p. 12)

Push and hold to transmit; release to receive.

## 2 LOCK SWITCH [LOCK]



Slide up to turn the lock function ON.

- [PTT], [VOL], [H/L], [MONI] and [POWER] function even when the lock function is activated.

## 3 ANTENNA CONNECTOR (p. 9)

Connects the supplied antenna.

## 4 EXTERNAL SPEAKER AND MICROPHONE JACKS [SP/MIC]

Connect an optional speaker-microphone or headset, if desired. The internal microphone and speaker will not function when either is connected. (See p. 28 for options.)

### ◇ External connection

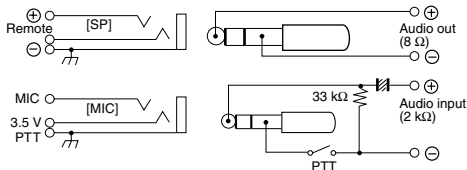

This connection does not apply when a condenser microphone is connected.

## 5 TUNING DIAL [DIAL]

Rotate [DIAL] to set an operating frequency, select a memory channel, select set mode contents, change scan direction, etc.

## 6 VOLUME CONTROL [VOL]

Rotate [VOL] clockwise to increase volume and counter-clockwise to decrease volume.

## 7 RX/TX INDICATOR [RX/TX] (p. 12)

Lights green while receiving a signal or when the squelch is open; lights red while transmitting.

## 8 MONITOR SWITCH [MONI] (p. 12)



➔ Push and hold this switch to force the squelch open; release to close it again.

➔ Push twice to keep the squelch open; push again to close it.

➔ While pushing this switch, rotate [DIAL] to set the squelch level.

➔ While pushing [PTT], push this switch to transmit a DTMF memory.

## 9 POWER SWITCH [POWER]



➔ Push for 1 sec. to toggle power ON and OFF.

- Battery voltage appears for 1 sec. after power ON.

## 10 BAND SWITCH [BAND/SCAN]



➔ Push to toggle between VHF and UHF operation except in memory mode (p. 10).

➔ Push and hold to indicate the selected scan range (or band) and to start scanning (p. 18).

- While scanning, each push of this switch changes the selected scan range.

**11 OUTPUT POWER SWITCH [H/L(SET)]**



- ➔ Push to toggle between low and high output power (p. 12).
  - “LOW” appears when low output power is selected.
- ➔ Push and hold to enter set mode.

**12 TONE SWITCH [TONE(DUP)]**



- ➔ Push this switch to activate the following functions in order (pgs. 21, 22).
  - Subaudible tone encoder—“T” appears.
  - Pocket beep—“T SQL (•)” appears.
  - Tone squelch—“T SQL” appears.
  - No tone operation—no indicator appears.
- ➔ Push this switch for 1 sec. to select semi-duplex or simplex operation (p. 13).
  - “- DUP” appears during minus duplex operation, “DUP” appears during plus duplex operation and no indicator appears during simplex operation.
- ➔ For the European version only, while pushing [PTT], push this switch to transmit a 1750 Hz tone burst signal (p. 13).

**13 VFO/CLEAR KEY [VFO(CLR MHz)]**



- ➔ Clears some functions, such as digit input before entry, scan, etc.
- ➔ Push this key to select VFO mode (p. 10).
- ➔ Push and hold for 1 sec., then rotate [DIAL] to change the MHz digit (p. 11).
- ➔ While pushing [PTT], this key sends a DTMF “A.”

**14 MEMORY MODE KEY [MR(SKIP)]**



- ➔ Push this key to select memory mode (p. 12).
  - “MR” appears while in memory mode.
- ➔ While in memory mode, push this key for 1 sec. to toggle the selected memory channel between a skip and a non-skip channel (p. 20).
  - “SKIP” appears when the channel is set as a skip channel.
- ➔ While pushing [PTT], this key sends a DTMF “B.”

**15 CALL MODE KEY [CALL]**



- ➔ Push this key to select the call channel (p. 15).
  - “C” appears while the call channel is selected.
- ➔ While pushing [PTT], this key sends a DTMF “C.”

**16 SELECT MEMORY WRITE KEY [S.MW(MW)]**



- ➔ Push this key to enter memory select mode.
  - “[MW]” flashes and the [DIAL] can be used for channel selection (for memory writing or clearing).
- ➔ Push and hold for 1 sec. to write the set contents into the selected memory channel (or VFO, call channel).
- ➔ Push then push and hold this key while in memory select mode to erase the contents of the selected memory channel.
- ➔ While pushing [PTT], this key sends a DTMF “D.”

# 1 PANEL DESCRIPTION

## 17 TONE SCAN KEY [TSCAN#]



➔ Push this key for 1 sec. to start and stop tone decode scan (p. 13).

- When a subaudible tone is detected, the tone frequency is displayed and overwrites the preprogrammed:

➔ tone squelch frequency when the *tone squelch* is in use;

➔ tone encoder (repeater tone) frequency when the *tone squelch* is not in use.

➔ While pushing [PTT], this key sends a DTMF “#.”

## 18 DTMF KEY [• (DTMF M)]



➔ Enters a decimal for MHz unit during frequency input (p. 10).

➔ Push and hold for 1 sec. to enter DTMF memory mode for programming or recall (p. 17).

- To program use [(H/L)SET].
- To transmit use [MONI] while transmitting.

➔ While pushing [PTT], this key sends a DTMF “\*.”

## 19 DIGIT KEYS

➔ Input the specified digit during frequency input, memory channel selection, etc.

➔ Transmit the DTMF code of the specified digit while pushing [PTT].

## 20 EXTERNAL DC POWER JACK [DC13.5V]

Allows operation with a 4.5 to 16 V DC power source using the optional cables, CP-12L or OPC-254L.

**CAUTION:** Operation with an external DC power source simultaneously charges batteries inside the battery case or the battery pack. When using dry cell batteries this may cause battery leakage and damage the transceiver; when using a Ni-Cd battery pack this may cause battery overcharging and shorten the life of the battery pack.

## 21 BATTERY PACK RELEASE (p. 8)

Push to open the latch for battery pack removal.



## ■ Function display

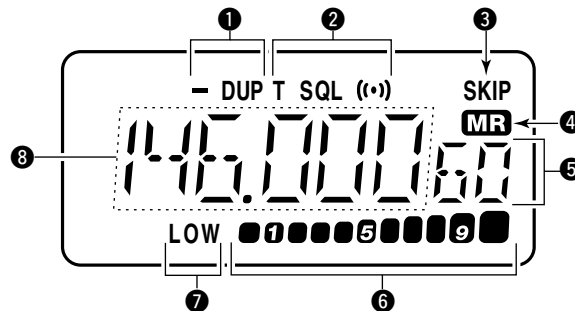

### ❶ DUPLEX INDICATORS (p. 13)

Appear during semi-duplex operation.

- “- DUP” appears for minus duplex; “DUP” only appears for plus duplex.

### ❷ TONE INDICATORS (p. 21)

“T” appears when the subaudible tone encoder is in use, “T SQL (••)” appears during pocket beep operation and “T SQL” appears when the tone squelch function is activated.

### ❸ SKIP INDICATOR (p. 20)

Appears when a selected memory channel is set as a skip channel.

### ❹ MEMORY MODE INDICATOR (p. 15)

Appears while in memory mode.

### ❺ MEMORY CHANNEL INDICATOR (p. 12)

Indicates the selected memory channel and other items such as the call channel, key lock indicator, etc.

### ❻ S/R/F INDICATORS (p. 12)

Show the relative signal strength while receiving, and the output power selection while transmitting.

### ❼ LOW POWER INDICATOR (p. 12)

Appears when low output power is selected.

### ❽ ALPHANUMERIC READOUTS

Show the selected frequency, set mode contents, etc.

## ■ Battery pack charging

The supplied\* BP-180 BATTERY PACK includes rechargeable Ni-Cd batteries and can be charged approx. 300 times. Charge the battery pack before first operating the transceiver or when the battery pack becomes exhausted.

\*Optional for versions which come with the BP-170 BATTERY CASE.

If you want to be able to charge the battery pack more than 300 times, the following points should be observed:

1. Avoid overcharging. The charging period should be less than 48 hours.
2. Use the battery until it becomes almost completely exhausted under normal conditions. We recommend battery charging just after transmitting becomes impossible.

## ■ Charging precautions

**NEVER** attempt to charge dry cell batteries. This will cause internal liquid leakage and damage the battery case and transceiver.

**NEVER** connect two or more chargers at the same time.

Charging may not occur under temperatures of 10°C (50°F) or over temperatures of 40°C (104°F).

## ■ About the battery pack

### ◇ Operating period

Depending on the attached battery pack, the operating period of the transceiver varies. Refer to p. 28 for battery pack specifications.

### ◇ Battery pack life

If your battery pack seems to have no capacity even after being fully charged, completely discharge it by leaving the power ON overnight. Then, fully charge the battery pack again.

If the battery pack still does not retain a charge (or very little), a new battery pack must be purchased.



### **Recycling information (U.S.A. only)**

The product that you purchased contains a rechargeable battery. The battery is recyclable. At the end of its useful life, under various state and local laws, it may be illegal to dispose of this battery into the municipal waste stream. Call 1-800-8-BATTERY for battery recycling options in your area or contact your dealer.

## ■ Charging connections

### ◇ Regular charging

Attach the supplied\* or optional battery pack; then, connect the supplied\* wall charger via an AC outlet as shown below.  
 \*Optional for versions which include a battery case.

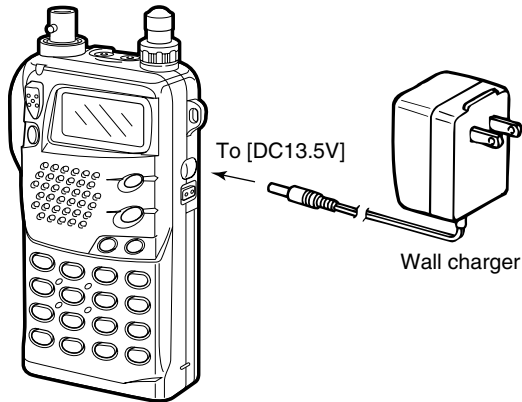

#### Charging periods:

15 hours (w/BP-171, BP-173 or BP-180)  
 20 hours (w/BP-172)

### ◇ Rapid charging with the BC-119

- ① Insert the AD-56A into the charging slot of the BC-119.
- ② Insert the AD-56B into the groove in the AD-56A (front-facing side of the AD-56A).
- ③ Insert the battery pack, either by itself or attached to the transceiver, into the AD-56B.

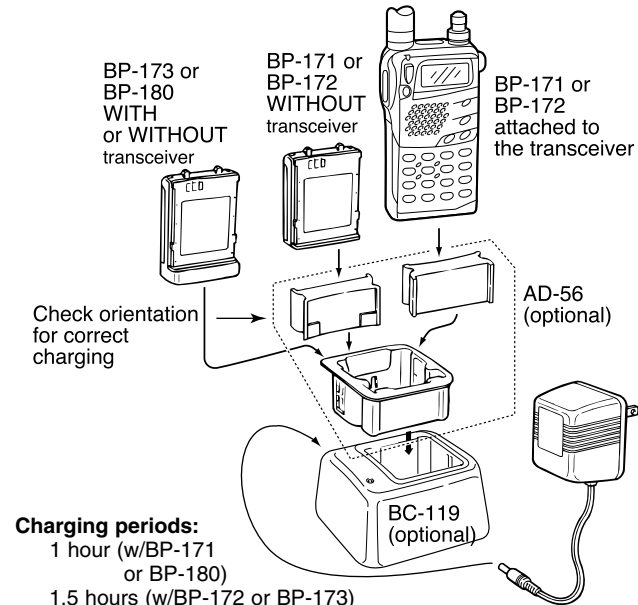

#### Charging periods:

1 hour (w/BP-171 or BP-180)  
 1.5 hours (w/BP-172 or BP-173)

## 2 BATTERY PACKS AND ACCESSORIES

### ◇ Operation with an optional cable

Connect an optional charger or cable to the transceiver as illustrated below. Be careful of battery overcharging as the connected battery is charged simultaneously.

**CAUTION:** Remove dry cell batteries when the BP-170 BATTERY CASE is connected, otherwise the battery may leak and damage the transceiver.

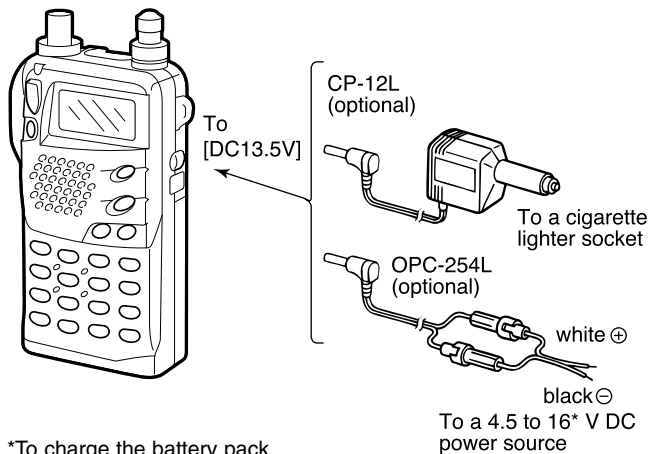

\*To charge the battery pack 12 to 16 V DC is necessary.

### ■ Battery case

When using a battery case attached to the transceiver, install LR6 (AA) size × 4 alkaline cells as illustrated below.

Remove the case from the transceiver.

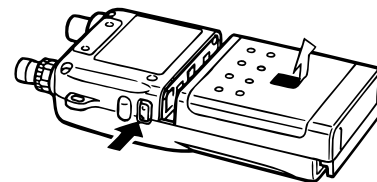

Open the case.

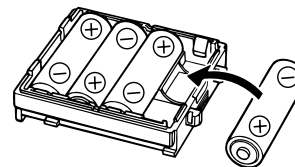
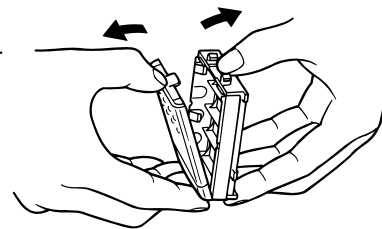

Install LR6 (AA) size × 4 dry cells into the battery case.

## ■ Accessory attachment

### ◇ Antenna

Insert the supplied antenna into the antenna connector and rotate the antenna as shown in the diagram below.

**Keep** the jack cover attached when jacks are not in use to avoid bad contacts.

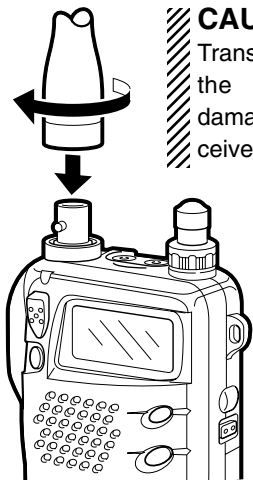

### CAUTION:

Transmitting without the antenna may damage the transceiver.

### ◇ Belt clip

Remove screws, then attach the belt clip using the same screws. Conveniently attaches to your belt.

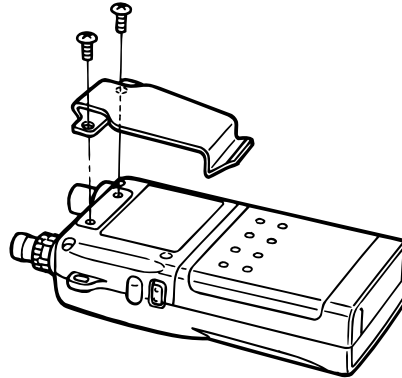

### ◇ Handstrap

Attach the handstrap as shown in the diagram below. Facilitates carrying.

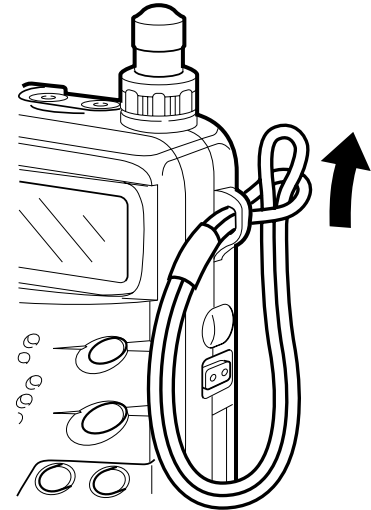

## ■ Power ON

Push and hold [POWER] for 1 sec. to turn power ON.

- Current battery voltage is displayed for 2 sec.

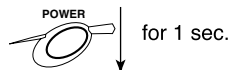

for 1 sec.

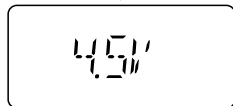

after 2 sec.

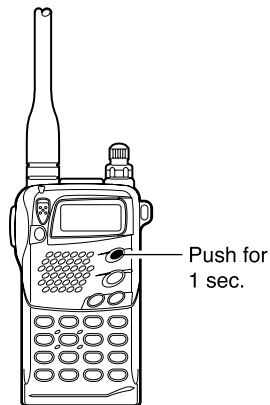
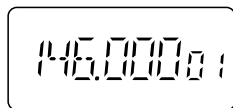

- The display shows the approx. voltage in 0.5 V steps.
- When the battery voltage is lower than 4.5 V, "LOW V" appears. Charge the battery in this case.
- If "OVER V" appears, **UNPLUG** the external DC plug immediately. Connected voltage is over 16 V and could damage the transceiver.

## ■ Setting a frequency

### ◆ Via the keypad (within a band)

- ① Push [VFO] to select VFO mode.

- ② Push [BAND] to select the VHF or UHF band.

- ③ Push 4 digit keys, starting from the 1 MHz digit and including the decimal point [.] , to input a frequency.

- When a digit is mistakenly input, push [VFO] and input from the beginning.

- "0," "2," "5" and "7" are acceptable for the 1 kHz digits (depending on the 10 kHz digit).

5

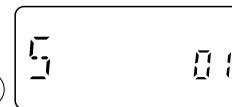

.

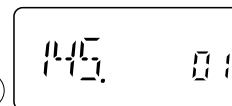

3

6

0

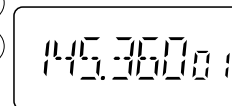

- ④ To change the frequency from the 100 kHz digit, push [.] , then 3 digits.

.

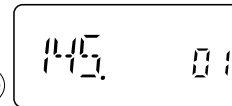

5

0

0

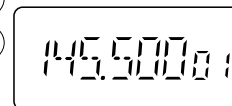

◇ **Via the keypad** (other band directly)

- ① Push [VFO] to select VFO mode.
- ② Push 6 digit keys, starting from the 100 MHz digit.
  - The operating band changes automatically.
  - It's not necessary to input the decimal point.

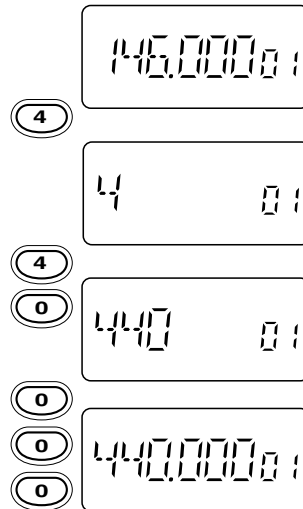

◇ **Other methods**

- *VIA THE DIAL*: Rotate [DIAL] to change the frequency according to the set tuning steps.
- *USING THE MHz STEP*: Push [(VFO)MHz] for 1 sec., then rotate [DIAL] to change the frequency in one MHz steps.

## ■ Setting tuning steps

*USING SET MODE*

This transceiver has 8 tuning steps (VHF and UHF bands have independent settings) as follows:

- 5 kHz    • 10 kHz    • 12.5 kHz    • 15 kHz
- 20 kHz    • 25 kHz    • 30 kHz    • 50 kHz

- ① Push [VFO] to select VFO mode.
- ② Push [BAND] to select the VHF or UHF band.
- ③ Push [(H/L)SET] for 1 sec. to enter set mode.
- ④ Push [TONE] or [H/L] several times until "TS" appears.
- ⑤ Rotate [DIAL] to select the desired tuning step.
- ⑥ Push [(VFO)CLR] to exit set mode.

For convenience, select a tuning step that matches the frequency intervals of repeaters in your area.

[DISPLAY EXAMPLE]

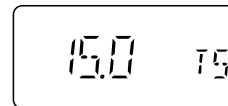

15 kHz tuning step

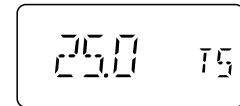

25 kHz tuning step

### 3 BASIC OPERATION

#### ■ Selecting a memory channel

- ① Push [MR] to select memory mode.
- ② Push 2 digit keys to select the desired memory channel (or rotate [DIAL]).
  - The first nine memory channels are preceded by a “0.”
  - To select scan edges 1A to 4B, use [A] for “A” and [B] for “B.”
  - Only programmed memory channels can be selected.

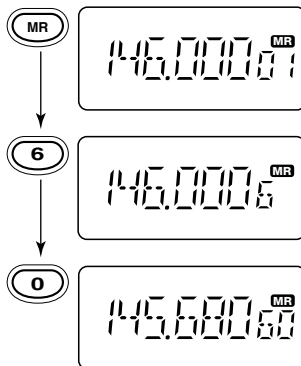

#### ■ Lock function

The lock function prevents accidental frequency changes and accidental function activation.

- ➔ Slide [LOCK] up or down to set the lock function ON or OFF, respectively.

- “L” appears while the lock function is activated.
- [PTT], [POWER], [VOL], [MONI], and [H/L] can be used regardless of this setting.

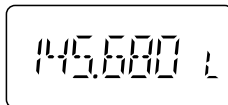

#### ■ Receive and transmit

- ① Push [POWER] for 1 sec. to turn power ON.
- ② Adjust the [VOL] control to the desired level.
  - While pushing [MONI], rotate [VOL].
- ③ Set the squelch level.
  - While pushing [MONI], rotate [DIAL].
  - 4 selections are available, “OP” (open), “AT” (automatic), 1 and 2.
- ④ Set an operating band and frequency.  
When a signal is received:
  - ➔ Squelch opens and audio is emitted from the speaker.
  - ➔ The S/Rf indicator shows the relative signal strength.
- ⑤ Push [H/L] to toggle output power between high and low.
  - “LOW” appears when low output power is selected.
- ⑥ Push and hold [PTT] to transmit; then speak into the mic.
  - **Do not** hold the microphone too close to your mouth or speak too loudly. This may distort the signal.
  - The TX/RX indicator lights red.
  - The S/Rf indicator shows the output power selection.
- ⑦ Release [PTT] to return to receive.

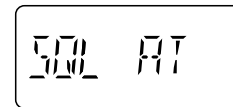

#### ✓ CONVENIENT

**Monitor function:** Push and hold [MONI] to listen to weak signals that do not open the squelch; or push [MONI] twice to monitor a signal without having to continuously hold [MONI].

**Squelch control:** The transceiver employs a *noise pulse count system* and therefore, squelch is adjusted automatically, when “AT” is selected.



## ■ Repeater operation

### ◇ General

When using a repeater, the transmit frequency is shifted from the receive frequency by the offset frequency. It is convenient to program repeater information into memory channels (p. 15).

- ① Set the operating band and receive frequency (repeater output frequency).
- ② Push [(TONE)DUP] for 1 sec. once to select – DUP or twice to select DUP.
  - “– DUP” or “DUP” appears to indicate the transmit frequency for minus shift or plus shift, respectively.
  - When the auto repeater function is in use (U.S.A. version only) this selection and step ③ are not necessary (p. 24).
- ③ Push [TONE] to activate the subaudible tone encoder, according to repeater requirements.
  - “T” appears.
  - Refer to the table of tone frequencies on the following page.
- ④ Push and hold [PTT] to transmit.
  - The displayed frequency automatically changes to the transmit frequency (repeater input frequency).
  - If “OFF” appears, check the offset frequency (p. 14).
- ⑤ Release [PTT] to receive.
- ⑥ Push and hold [MONI] to check whether the other station’s transmit signal can be directly received or not.

### ◇ Tone information

Some repeaters require a tone to be accessed. In this case, precede step ④ at left with the required tone.

#### DTMF TONES (U.S.A. and Asia versions only)

While pushing [PTT], push the desired digit key(s) to transmit DTMF tones

- The transceiver has 9 DTMF memory channels. See p. 17 for details.

#### 1750 Hz TONE (Europe and Italy versions only)

While pushing [PTT], push and hold [TONE] for 1 to 2 sec. to transmit a 1750 Hz tone signal.

---

#### ✓ CONVENIENT

**Tone scan function:** When you don’t know the subaudible tone used for a repeater, the tone scan is convenient for detecting the tone frequency.

Push and hold [T SCAN#] to activate. See p. 22 for more information.

---

### 3 BASIC OPERATION

#### ◇ Setting subaudible tones for repeater use

USING SET MODE

Some repeaters require subaudible tones to be accessed. Subaudible tones are superimposed over your normal signal and must be set in advance.

- ① Push [VFO] to select VFO mode.
- ② Push [BAND] to select VHF or UHF.
- ③ Push [(H/L)SET] for 1 sec. to enter set mode.
- ④ Push [TONE] or [H/L] several times until "rT" appears.
- ⑤ Rotate [DIAL] to select the desired subaudible tone.
- ⑥ Push [(VFO)CLR] to exit set mode.

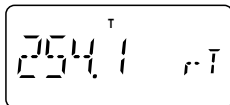
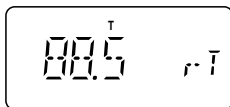

#### • Available subaudible tone frequencies (unit: Hz)

67.0	79.7	94.8	110.9	131.8	156.7	171.3	186.2	203.5	229.1
69.3	82.5	97.4	114.8	136.5	159.8	173.8	189.9	206.5	233.6
71.9	85.4	100.0	118.8	141.3	162.2	177.3	192.8	210.7	241.8
74.4	88.5	103.5	123.0	146.2	165.5	179.9	196.6	218.1	250.3
77.0	91.5	107.2	127.3	151.4	167.9	183.5	199.5	225.7	254.1

#### ◇ Setting an offset frequency

USING SET MODE

When communicating through a repeater, the transmit frequency is shifted from the receive frequency by an amount determined by the offset frequency.

- ① Push [VFO] to select VFO mode.
- ② Push [BAND] to select VHF or UHF.
- ③ Push [(H/L)SET] for 1 sec. to enter set mode.
- ④ Push [TONE] or [H/L] several times until "OW" appears.
- ⑤ Rotate [DIAL] to select the desired offset.
  - Selectable steps are the same as the pre-set tuning steps.
  - MHz step may be helpful for large frequency changes—push [(VFO)MHz] for 1 sec.
- ⑥ Push [(VFO)MHz] to exit set mode.

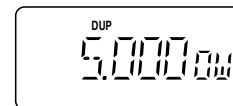
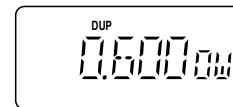

### ■ Auto low power

When transmitting for 6 continuous min. at high power, the IC-T7H automatically selects low power. This function cannot be turned OFF and activates when the power supply is at approx. 11 V or more. To return to high power on transmit, select receive, then switch back to transmit.

## ■ Memory/call channels

The transceiver has 70 memory channels (60 regular, 4 pairs of scan edge channels for mixed bands and 1 call channel for each band). Note that memory channels are not grouped according to band. In other words, a given memory channel can be programmed with either a VHF frequency or a UHF frequency. This is not the case with call channels. Call channels are band specific.

The following can be programmed into memory/call channels:

- Operating frequency
- Duplex direction with an offset frequency (pgs. 13, 14)
- Subaudible tone encoder or tone squelch ON/OFF with a tone (CTCSS) frequency (pgs. 21, 22)
- Skip information (p. 20)

### ◇ Programming during selection

① Push [VFO] to select VFO mode.

② Set the desired frequency:

- ➔ Set other data, such as repeater information, etc. using set mode if required.

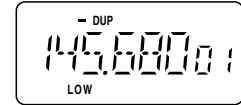

③ Push [S.MW] momentarily.

- "MR" flashes.
- Do not hold [S.MW] for more than 1 sec., otherwise the memory channel will overwrite the displayed number.

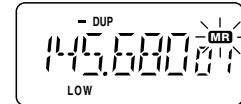

④ Rotate [DIAL] to select the desired channel.

- Call channel and scan edge channels, as well as regular memory channels, can be programmed in this way.
- If you want to confirm the VFO frequency, push [S.MW] momentarily.



⑤ Push [S.MW] for 1 sec. to program.

- "MR" stops flashing.

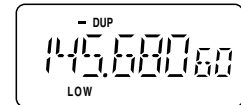

## 4 ADVANCED FUNCTIONS

### ◇ Programming after selection

- ① Select the memory channel to be programmed:
  - ➔ Push [MR] to select memory mode.
  - ➔ Rotate [DIAL] (or use the keypad) to select the memory channel.
    - Non-programmed channels cannot be selected.
- ② Set the desired frequency in VFO mode:
  - ➔ Push [VFO] to select VFO mode.
  - ➔ Set the desired frequency using the keypad or [DIAL].
  - ➔ Set other data, if desired.
- ③ Push [S.MW] for 1 sec. to program.

### ◇ Memory/call ⇒ VFO

- ① Select the memory/call channel to be transferred:
  - ➔ Push [MR] (or [CALL]) to select memory (call) mode.
  - ➔ Rotate [DIAL] (or use the keypad) to select the memory channel.
- ② Push [S.MW] for 1 sec. to transfer to VFO.

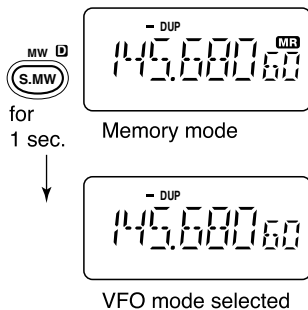

### ◇ Memory/call ⇒ call/memory

- ① Select the memory/call channel to be transferred:
  - ➔ Push [MR] (or [CALL]) to select memory (call) mode.
  - ➔ Rotate [DIAL] (or use the keypad) to select the memory channel.
- ② Push [S.MW] momentarily.
  - A beep sounds, “VF” appears and “MR” flashes.
  - Do not hold [S.MW] for more than 1 sec., otherwise the memory channel will overwrite the VFO.
- ③ Rotate [DIAL] to select a memory or call channel to transfer the data.
- ④ Push [S.MW] for 1 sec. to program.
  - “MR” stops flashing.

### ◇ Memory clear

- ① Push [S.MW] momentarily.
- ② Select the memory channel to be cleared with [DIAL].
- ③ Push [S.MW] briefly, then a second time for 1 sec.
  - 3 beeps sound, then the frequency is cleared.
  - “MR” flashes continuously.
  - Scan edges 1A and 1B and call channels cannot be cleared.
- ④ Push [(VFO)CLR] to stop the flashing.

**NOTE:** Be careful — the contents of cleared memories **CANNOT** be recalled.

## ■ DTMF memory operation

### ◇ Programming a DTMF code

The transceiver has 9 DTMF memory channels (D1 to D9) for storage of often-used DTMF codes of up to 16 digits.

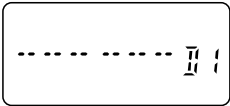
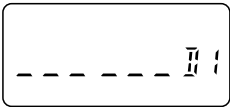
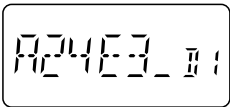
- ① Push [(\*)DTMF] for 1 sec. to enter DTMF memory mode. 
- ② Rotate [DIAL] to select the desired channel. 
- ③ Push [(H/L)SET] for 1 sec. to enter DTMF programming mode.
  - “-----” appears.
  - Programmed memories can be cleared in this way.
- ④ Push digit keys to enter the desired DTMF code.
  - A maximum of 16 digits can be input.
  - If a digit is mistakenly input, push [H/L] then repeat from step ③.
- ⑤ Push [(H/L)SET] to input the digits.
  - A beep sounds.
- ⑥ Push [VFO] or [MONI] to exit DTMF programming mode.
  - When pushing [MONI], the programmed contents can be monitored.

### ◇ Transmitting a DTMF code

- ① Select the DTMF channel to be transmitted:
  - ➔ Push [(\*)DTMF] for 1 sec. to select DTMF memory mode.
  - ➔ Rotate [DIAL] to select the desired DTMF channel.
- ② While pushing [PTT] push [MONI] to transmit the selected DTMF channel's contents.

### ◇ DTMF transmit speed

AT **POWER ON**

When slow DTMF transmission speeds are required (such as for some repeaters) the transceiver's rate of DTMF transmission can be adjusted. See p. 25 for details.

## 4 ADVANCED FUNCTIONS

### ■ Scan operation

#### ◇ Full/programmed scan

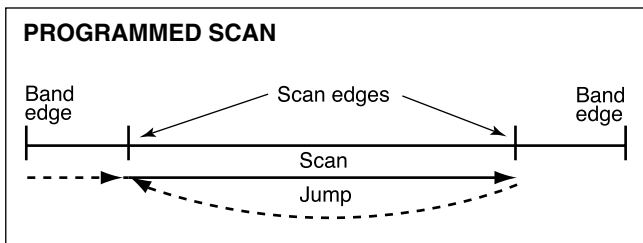
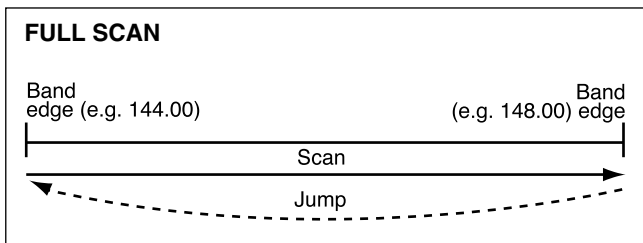

**FULL SCAN:** Repeatedly scans all frequencies over an entire band (the 144 MHz band or the 430(440) MHz band).

**PROGRAMMED SCAN:** Repeatedly scans between two user-programmed frequencies. Used for checking for frequencies within a specified range such as repeater output frequencies, etc. Four pairs of scan edges are available.

- ① Push [VFO] to select VFO mode.
- ② Push [(BAND)SCAN] for 1 sec.; then, while continuing to push [(BAND)SCAN], rotate the tuning dial to select the desired scan range.
  - The following scan ranges are selectable:
    - “ALL 144” for full scan on the 144 MHz band.
    - “ALL 430” or “ALL 440” for full scan on the 430(440) MHz band.
    - “PROG 1” to “PROG 4” for one of the programmed scans.
  - After releasing [(BAND)SCAN] the selected scan starts.
  - To activate the previously selected scan, dial rotation is not necessary—just push [(BAND)SCAN] for 1 sec.
  - During scan, the following can be changed:
    - Scan range using [(BAND)SCAN], with/without [DIAL].
    - Scan direction using [DIAL].
- ③ To stop the scan, push [(VFO)CLR].

**NOTE:** For programmed scan, scan edges must be programmed in advance (1A/1B are programmed by default). Program scan edges in the same manner as regular memory channels (p. 15)

If the same frequencies are programmed into a pair of scan edges, programmed scan edge flashes, such as “P1,” but programmed scan does not proceed.

◇ Memory (skip) scan

**ALL CHANNEL SCAN**

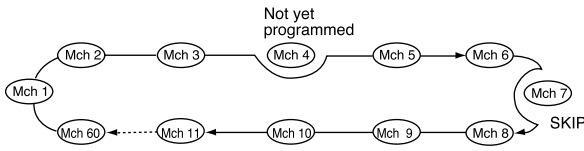

**BAND SELECT SCAN (Example: 144 MHz band)**

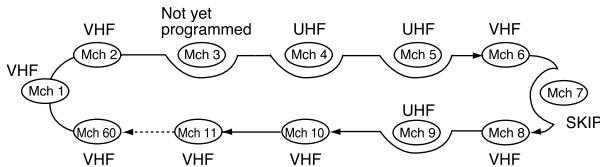

**ALL CHANNEL SCAN:** Repeatedly scans all programmed memories, except for those set as skip channels.

**BAND SELECT SCAN:** Repeatedly scans all memories with programmed frequencies in the 144 MHz band or 430(440) MHz band, except for those set as skip channels.

- ① Push [MR] to select memory mode.
- ② While pushing [(BAND)SCAN] rotate the tuning dial to select the desired band.
  - The following scan bands are selectable:
    - “SEL ALL” for all channel scan.
    - “SEL 144” for selected band scan of the 144 MHz band.
    - “SEL 430” or “SEL 440” for selected band scan of the 430(440) MHz band, depending on version.
  - After releasing [(BAND)SCAN], the selected scan starts.
  - To activate the previously selected scan, dial rotation is not necessary—just push [(BAND)SCAN] for 1 sec.
  - During scan, the following can be changed:
    - Scan range using [(BAND)SCAN], with/without [DIAL].
    - Scan direction using [DIAL].
- ③ To stop the scan, push [(VFO)CLR].

## 4 ADVANCED FUNCTIONS

### ◇ Setting a skip channel

Memory channels can be set to be skipped during memory scan. This is useful to speedup the memory scan interval.

- ① Select the memory channel to be programmed as a skip channel:

- ➔ Push [MR] to select memory mode.
- ➔ Rotate [DIAL] (or use the keypad) to select a memory channel.

- ② Push [(MR)SKIP] for 1 sec. to set the memory channel as a skip channel.

- “SKIP” appears.

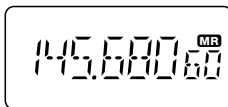

- ③ Repeat step ② to cancel a skip channel.

- “SKIP” disappears.

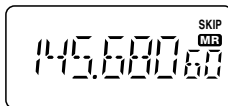

**NOTE:** Scan edge channels, 1A to 4B, cannot be set to show “SKIP” settings, however, they will be skipped during memory scan.

### ◇ Scan resume condition

USING SET MODE

The resume condition can be selected as a pause or timer scan. This setting is common for all scans.

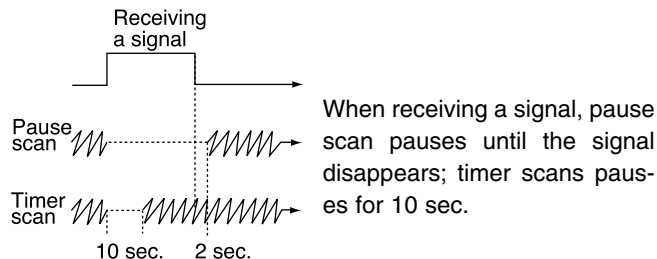

- ① Push [(H/L)SET] for 1 sec. to enter set mode.

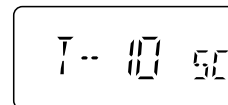

- ② Push [H/L] or [TONE] one or more times until “SC” appears.

- ③ Rotate [DIAL] to select the desired scan resume condition.

- “T-10”: scan pauses for 10 sec. on a received signal.

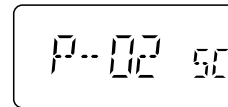

- “P-02”: scan pauses on a received signal until it disappears.

- ④ Push [(VFO)CLR] to exit set mode.



## ■ Subaudible tone operation

### ◇ Tone squelch operation

The tone squelch opens only when receiving a signal containing a matching subaudible tone. You can silently wait for calls from group members using the same tone.

- ① Set the operating frequency.
- ② Set the desired subaudible tone in set mode.
  - See right for programming.
- ③ Push [TONE] one or more times until “TSQL” appears.
- ④ When the received signal includes a matching tone, squelch opens and the signal can be heard.
  - When the received signal’s tone does not match, tone squelch does not open, however, the S-indicator shows signal strength.
  - To open the squelch manually, push and hold [MONI].
- ⑤ Operate the transceiver in the normal way.
- ⑥ To cancel the tone squelch, push [TONE].

/// **NOTE:** The transceiver has 50 tone frequencies and consequently their spacing is narrow compared with units having 38 tones. Therefore, some tone frequencies may receive interference from adjacent tone frequencies.

### ✓ CONVENIENT

Store subaudible tone frequencies and tone squelch ON/OFF settings in memories (call) for easy recall.

### ◇ Setting subaudible tones for USING SET MODE tone squelch operation (CTCSS tones)

Separate tone frequencies can be set for tone squelch operation than for repeater operation (the same range of tones is available—see below). Like repeater tones, these are set in set mode.

- ① Select VFO or a memory channel.
- ② Push [(H/L)SET] for 1 sec. to enter set mode.
- ③ Push [TONE] or [H/L] one or more times until “CT” appears.
- ④ Rotate [DIAL] to select the desired subaudible tone.
- ⑤ Push [(VFO)CLR] to exit set mode.

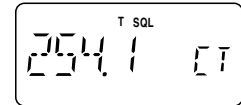
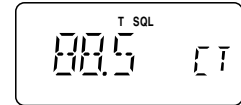

### • Available subaudible tone frequencies (unit: Hz)

67.0	79.7	94.8	110.9	131.8	156.7	171.3	186.2	203.5	229.1
69.3	82.5	97.4	114.8	136.5	159.8	173.8	189.9	206.5	233.6
71.9	85.4	100.0	118.8	141.3	162.2	177.3	192.8	210.7	241.8
74.4	88.5	103.5	123.0	146.2	165.5	179.9	196.6	218.1	250.3
77.0	91.5	107.2	127.3	151.4	167.9	183.5	199.5	225.7	254.1

## 4 ADVANCED FUNCTIONS

### ◇ Pocket beep operation

This function uses subaudible tones for calling and can be used as a “common pager” to inform you that someone has called while you were away from the transceiver.

- ① Set the operating frequency.
- ② Set the desired subaudible tone (same as that used for tone squelch operation, “CT”) in set mode.
  - See p. 21 for programming.
- ③ Push [TONE] two times until “TSQL ((•))” appears.
- ④ When a signal with a matched tone is received, the transceiver emits beep tones for 30 sec. and flashes “((•)).”
- ⑤ Push [PTT] to answer or push [VFO] to stop the beeps and flashing.
  - Tone squelch is automatically selected.

### ◇ Calling a waiting station using pocket beep

A subaudible tone matched with the station’s tone frequency is necessary. Use the tone squelch on p. 21 or a subaudible tone encoder.

### ◇ Tone scan

The transceiver can detect the subaudible tone frequency in a received signal. By monitoring a signal, such as that being transmitted on a repeater input frequency, you can determine the tone frequency required to access the repeater.

- ① Set the desired frequency or memory channel to be checked for a tone frequency.
- ② Push [T SCAN] for 1 sec. to start the tone scan.
  - To change the scanning direction, rotate [DIAL].
- ③ When the tone frequency is decoded, the set mode contents are programmed with the tone frequency.
  - The decoded tone frequency is used for the tone encoder or tone encoder/decoder, depending on the the tone squelch ON/OFF setting.
  - “CT” or “rT” appears during tone scan when the tone squelch is in use or not, respectively.
- ④ Push [VFO] to stop the scan.

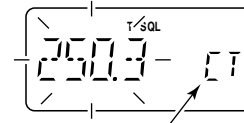

“CT” appears during tone scan with tone squelch

Subaudible tone frequencies flash as they are scanned.

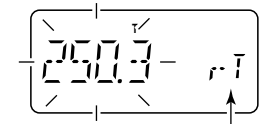

“rT” appears during tone scan without tone squelch.

## Initial set mode

AT POWER ON

Initial set mode is accessed at power ON and allows you to set seldom-changed settings. In this way you can “customize” transceiver operation to suit your preferences and operating style.

### ◇ Entering initial set mode

- ① While pushing [(H/L)SET] push [POWER] to turn power ON.
  - The transceiver enters initial set mode and the last-selected (or default) item is displayed.
- ② Push [H/L] or [TONE] one or more times to select the desired display as described on the following pages.
- ③ Rotate [DIAL] to select the desired condition.
- ④ Push [VFO] to exit initial set mode and select VFO operation.

### ◇ Message

When no operation is performed for 5 sec. in initial set mode, a message scrolls across the function display prompting you for input.

#### • Message example

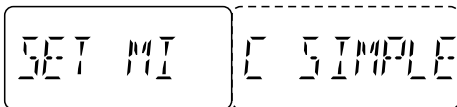

for microphone simple mode

### ◇ Optional HM-75A functions

This item turns the microphone simple mode ON or OFF. Microphone simple mode is used to change the function assignments for switches on the optional HM-75A REMOTE CONTROL MICROPHONE as below. This assignment is convenient for 3-channel use of simple operation.



SWITCH	NORMAL	SIMPLE
	VHF/UHF Toggles VHF and UHF. No function in memory mode.	MONITOR Toggles squelch between open/close.
	VFO/MEMORY Toggles VFO and memory mode.	CALL Selects the call channel.
	UP Change the frequency or memory channel when pushed.	M1 Selects memory channel 1.
	DOWN Starts previously selected scan when pushed and held.	M2 Selects memory channel 2.

**NOTE:** VFO mode cannot be selected via the microphone when SIMPLE mode is selected.

## 5 OTHER FUNCTIONS

### ◇ Auto power OFF

This item allows you to set a time at which the transceiver will automatically turn OFF. The power OFF time can be set to 20, 40, 60 min. or turned OFF.

OFF 00

60 00

### ◇ Function display backlighting

When set to AUTO, display backlighting automatically turns on when a key is pushed; when set to OFF display backlighting cannot be turned ON; when set to ON display backlighting remains ON continuously.

AUTO LI

OFF LI

ON LI

### ◇ Beep tones ON/OFF

Beep tones can be turned ON or OFF as you prefer.

ON BE

OFF BE

### ◇ Auto repeater function (U.S.A. only)

The U.S.A. version automatically activates repeater settings (duplex ON/OFF, duplex direction, tone encoder ON/OFF) when the operating frequency falls within the general repeater output frequency range. The offset frequency and repeater tone frequency are not changed by the auto repeater function.

ON 1 R.

Activates for duplex only.

ON 2 R.

Activates for duplex and tone.

◇ Power saver duty cycle

This item sets the power saver duty cycle — the ratio of receive circuit ON to receive circuit OFF while standing by. The duty cycle can be set to AUTO, 1:4 or OFF. Setting to AUTO conserves the most battery power.

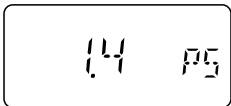
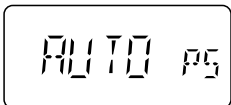

<b>AUTO</b>	Selects "1:4" duty ratio when receiving no signal for 5 sec., then "1:8" 60 sec. after that.	The power saver is deactivated when more than 12 V DC is connected to the [DC13.5V] jack.
<b>1:4</b>	Standby : 125 msec. circuit idle : 500 msec.	
<b>OFF</b>	No power save function.	

◇ Battery voltage indication ON/OFF

This item sets the battery voltage indication ON or OFF. When set to ON, the battery voltage is indicated for 2 sec. at power ON (LOW V, 4.5-16 V in 0.5 V steps). If the voltage surpasses 16 V, "OVER V" appears and flashes regardless of this setting.

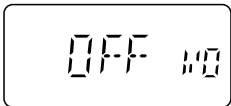
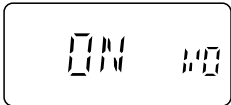

◇ DTMF speed

When slow DTMF transmission speeds are required (such as for some repeaters) the transceiver's rate of DTMF transmission can be adjusted.



fastest (100 msec. intervals)

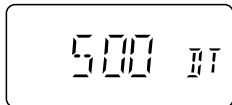

slowest (500 msec. intervals)

◇ LCD contrast

This item sets function display contrast to one of 2 levels. "1" is for low contrast and "2" is for high contrast.

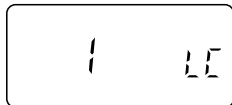

low contrast

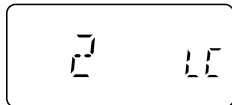

high contrast

## 5 OTHER FUNCTIONS

### ■ Channel indication mode

AT POWER ON

Channel indication mode is used to simplify operation. In this mode only pre-programmed memory channel numbers are displayed and functions are limited ([POWER], [LOCK], [PTT], [MONI], [H/L], [SCAN] and the tuning dial are functional).

➔ While pushing [MR], push [POWER] to turn power ON.

- Repeat this operation to return to normal indication.
- Needed frequencies must be programmed into memory channels in advance.



### ■ CPU resetting

AT POWER ON

Reset the the CPU before operating the transceiver for the first time, or when the internal CPU malfunctions.

➔ While pushing [MR] + [VFO] + [BAND] turn power ON to reset the transceiver.

**CAUTION:** Resetting the CPU returns all programmed contents to their default settings.

If your transceiver seems to be malfunctioning, please check the following points before sending it to a service center.

PROBLEM	POSSIBLE CAUSE	SOLUTION	REF.
No power comes on.	<ul style="list-style-type: none"> <li>The battery is exhausted. (A slight current flows in the circuits even when the power is OFF.)</li> <li>Poor plug connection to the external DC power cable.</li> </ul>	<ul style="list-style-type: none"> <li>Charge the battery pack or place new dry cell batteries in the battery case. (Remove the battery pack if you will not be using the transceiver for a long time.)</li> <li>Check the connector or remove and replace the cable.</li> </ul>	<p>pgs. 7, 8</p> <p>—</p>
Transmitting is impossible.	<ul style="list-style-type: none"> <li>The battery is exhausted.</li> </ul>	<ul style="list-style-type: none"> <li>Charge the battery pack or place new dry cells in the battery case.</li> </ul>	<p>pgs. 7, 8</p>
Frequency cannot be set.	<ul style="list-style-type: none"> <li>Memory mode, call channel or channel indication mode is selected.</li> <li>The lock function is activated.</li> </ul>	<ul style="list-style-type: none"> <li>Push [VFO] to select VFO mode.</li> <li>Set [LOCK] down to deactivate the lock function.</li> </ul>	<p>p. 10</p> <p>p. 12</p>
Scan does not function.	<ul style="list-style-type: none"> <li>The same frequencies are programmed into XA and XB.</li> </ul>	<ul style="list-style-type: none"> <li>Program different frequencies.</li> </ul>	<p>p. 18</p>
[▲] or [▼] keys do not function when using the optional HM-75A.	<ul style="list-style-type: none"> <li>Memory channels 1 and/or 2 are not programmed and simple mode is selected.</li> </ul>	<ul style="list-style-type: none"> <li>Program the memory channels or set to microphone normal.</li> </ul>	<p>p. 15</p>
Squelch does not open for received signals.	<ul style="list-style-type: none"> <li>Tone squelch is activated.</li> </ul>	<ul style="list-style-type: none"> <li>Turn OFF the tone squelch.</li> </ul>	<p>p. 21</p>
No beep sounds even when a key is pushed.	<ul style="list-style-type: none"> <li>Beep tones are turned OFF in initial set mode.</li> </ul>	<ul style="list-style-type: none"> <li>Set beep tones ON in initial set mode.</li> </ul>	<p>p. 24</p>

### ◇ Battery packs

BATTERY PACK	HEIGHT (mm/in)	VOLTAGE	CAPACITY	OUTPUT POWER	OPER. PERIOD* <sup>1</sup>
<b>BP-170</b>	63.5/2.5	Battery case for LR6 (AA) × 4 alkaline cells		2.0 (1.5) W	20 (19) h* <sup>2</sup>
<b>BP-171</b>	63.5/2.5	4.8 V	700 mAh	2.0 (1.5) W	6.2 (5.5) h
<b>BP-172</b>	63.5/2.5	4.8 V	950 mAh	2.0 (1.5) W	8.3 (7.5) h
<b>BP-173</b>	75.5/3.0	9.6 V	650 mAh	5.0 (4.5) W	4.3 (4.2) h
<b>BP-180</b>	75.5/2.5	7.2 V	600 mAh	3.9 (2.8) W	4.2 (4.2) h

In the output power and operating period columns, bracketed values refer to the 440 (430) MHz band.

\*<sup>1</sup> Operating periods are calibrated for the following conditions:

Tx : Rx : standby=1 : 1 : 8 min.

\*<sup>2</sup> Operating period depends on alkaline cells used.

### ◇ Chargers and cables

#### **BC-110A/D/V** WALL CHARGER

Regularly charge battery packs attached to the transceiver in 15 to 20 hrs.

#### **BC-119** DESKTOP CHARGER + **AD-56** BATTERY PACK ADAPTER

Rapidly charge battery packs in 1 to 1.5 hrs. depending on the battery pack. An AC adapter is packed with the BC-119. The AD-56 must be used with the BC-119 for charging the battery pack. The CP-17L or OPC-515L can be used instead of the supplied AC adapter.

#### **CP-12L** CIGARETTE LIGHTER CABLE WITH NOISE FILTER

For operation and charging via a 12 V cigarette lighter socket.

#### **OPC-254L** DC POWER CABLE

For operation and charging via an external power supply.

### ◇ Speaker-microphones

#### **HM-46**



#### **HM-54**



#### **HM-75A**



Remote control capability (see p. 23 for details)

#### **HS-85** HEADSET



- PTT switch
- VOX
- One-touch PTT for hands-free operation

### ◇ Others

#### **MB-30** MOUNTING BRACKET

For mounting the transceiver on the inside door panel of a vehicle or on a wall.

#### **LC-136/LC-137** CARRYING CASES

LC-136: for IC-T7H with BP-170/171/172.

LC-137: for IC-T7H with BP-173/180.

#### **SP-13** EARPHONE

Provides clear receive audio in noisy environments.

#### **CS-T7** CLONING SOFTWARE + **OPC-478** CLONING CABLE

Provide quick and easy programming of memory channels and set mode contents, etc. via a PC.



# SPECIFICATIONS

# 8

		VHF	UHF
		Frequency coverage (MHz)	U.S.A.
Europe, U.K.	144–146		430–440
Asia	Tx: 144–148 Rx: 118–174* <sup>1</sup>		430–440
Italy	Tx: 144–148 Rx: 136–174* <sup>1</sup>		Tx: 430–440 Rx: 400–470* <sup>3</sup>
Guaranteed ranges are: * <sup>1</sup> 144–148 * <sup>2</sup> 440–450 * <sup>3</sup> 430–440			
Mode		FM (F3E)	
Frequency stability		±5 ppm (0°C to +50°C; +32°F to +122°F)	
Tuning steps (kHz)		5, 10, 12.5, 15, 20, 25, 30 or 50	
Antenna connector		BNC (50 Ω)	
Usable battery pack/case		See options on page 28.	
External DC power		4.5 to 16 V DC (negative ground)	
Current drain (at 13.5 V, typ.)	Tx	High	1.6 A
		Low	600 mA
	Rx	Rated audio	180 mA
		Power saved (at 9.6 V)	16 mA (average)
Usable temperature range		–10°C to +60°C; (+14°F to +140°F)	
Dimensions (with BP-180) (projections not included)		57(W)×122(H)×29(D) mm; 2¼(W)×4 <sup>13</sup> / <sub>16</sub> (H)×1 <sup>5</sup> / <sub>32</sub> (D) in	
Weight <sup>†1</sup> (with BP-180)		approx. 320 g; 11.3 oz	

		VHF	UHF
TRANSMITTER	Output power* (at 13.5 V)	6 W, 0.5 W (selectable)	6 W, 0.5 W (selectable)
	Modulation system	Variable reactance frequency modulation	
	Max. freq. deviation*	±5.0 kHz	
	Ext. microphone jack	2.5 mm (1/10 in) 3-conductor/2 kΩ	

RECEIVER	Receive system	Double conversion superheterodyne	
	Intermediate frequencies	1st: 45.15 MHz	2nd: 450 kHz
	Sensitivity* (12 dB SINAD)	Less than 0.18 μV	
	Squelch sensitivity	Less than 0.18 μV	
	Selectivity	More than 15 kHz/–9 dB	
		Less than 30 kHz/–50 dB	
	Spurious and image rejection ratio*	More than 60 dB	More than 50 dB
		More than 50 dB at IF/2	
Audio output power* (at 13.5 V)	More than 500 mW (at 10% distortion with an 8 Ω load)		
Ext. microphone jack	3.5 mm (1/8 in) 3-conductor/8 Ω		

\*Specifications guaranteed at a transceiver temperature of +25°C (+77°F).

<sup>†1</sup>With the battery case: approx. 300 g; 10.6 oz (include in antenna, BP-170 and LR6 (AA) × 4 alkaline cells)

**All stated specifications are subject to change without notice or obligation.**

# 9

## MODE ARRANGEMENT

NOTE: Displays for set and initial set modes show the default settings—rotate [DIAL] to change the condition.

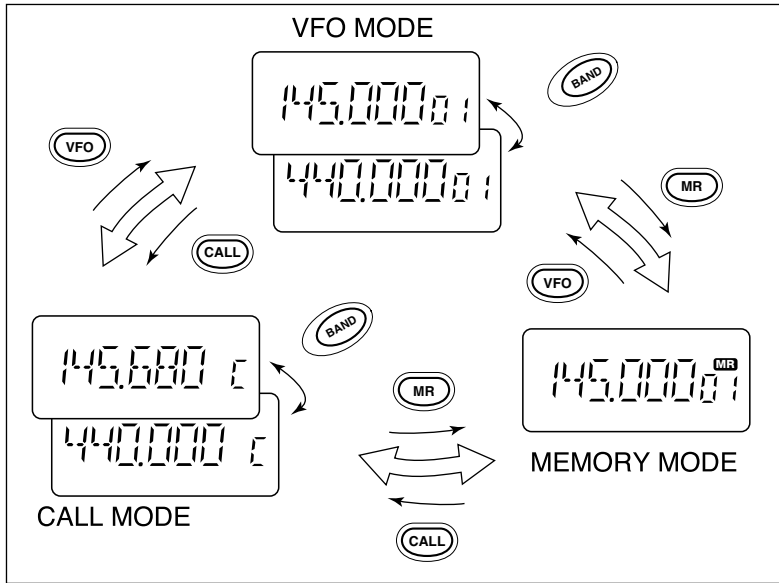

SET  
W/L push for 1 sec.

DTMF-M  
push for 1 sec.

CLR MHz  
VFO

### DTMF MEMORY MODE

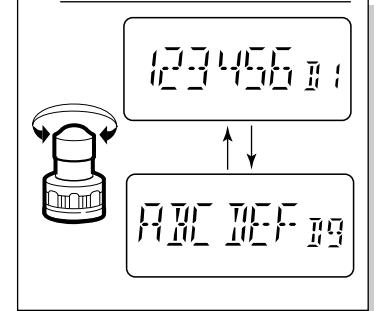

### CHANNEL INDICATION MODE

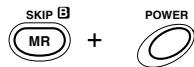

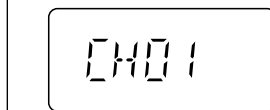

AT POWER ON



See p. 26 for details

SET MODE

CLR MHz 

SET 

CTCSS tones (p. 21)

T SQL

005 CT

DUP 

Repeater tones (p. 14)

005 RT

Tuning step\* (p. 11)

200 TS

Scan resume condition (p. 20)



T- 0 SC

Offset frequency\* (p. 14)

06000

\*Cannot be selected when entering set mode from a memory or call channel.

INITIAL SET MODE

TO ENTER  + SET  at power ON

SET 

MIC simple mode (p. 23)

1000000 TS

DUP 

Auto power OFF (p. 24)

OFF AO

LCD backlight (p. 24)

AUTO LI

Beep tones (p. 24)

ON BE

Auto repeater (p. 24)

OFF Ar

U.S.A. version only

LCD contrast (p. 25)

1 LC

DTMF speed (p. 25)



100 IT

Battery voltage (p. 25)

ON VO

Power saver duty (p. 25)

AUTO PS

TO EXIT  

**Count on us!**

A-5551D-1EX-②

Printed in Japan

© 1998–2007 Icom Inc.

Printed on recycled paper with soy ink.

**Icom Inc.**

1-1-32 Kamiminami, Hirano-ku, Osaka 547-0003, Japan